

NOT RELEASED FOR PRODUCTION

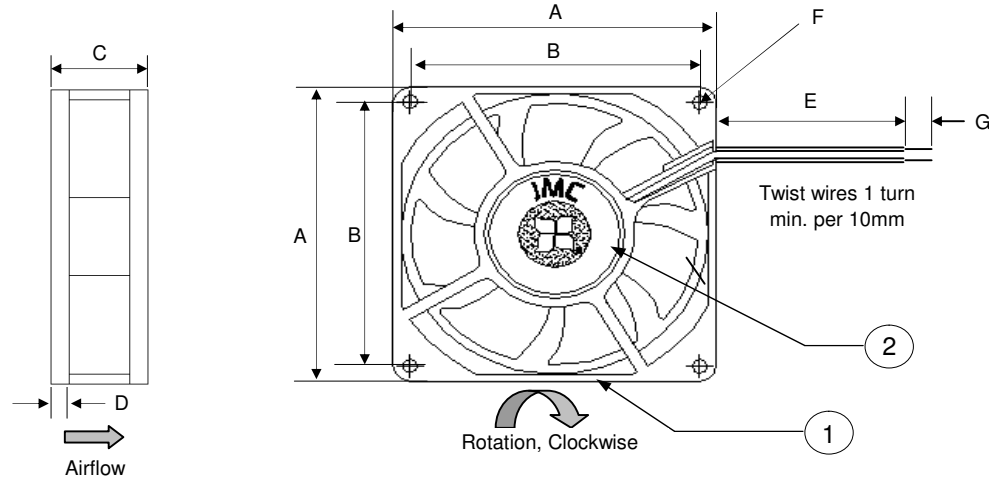

Revision History				
EC No	REV	Date	Description	Approvals
NA	X00	6/6/08	Created Drg.	SA
NA	X01	7/31/14	Updt. RPM	JE

NOTES

1. THIS FAN AND ALL OF ITS COMPONENTS COMPLY WITH THE REQUIREMENTS OF RoHS DIRECTIVE 2011/65/EU
2. BASE MODEL FAN - ANY CHANGES TO SPECIFICATION REQUIRES NEW PART NUMBER AND DRAWING.

WIRE DESIGNATION	
WIRE COLOR	FUNCTION
Black	GND (-)
Red	PWR (+)

All Dimensions in mm	
A	92 +/- 0.5
B	82.5 +/-0.3
C	32.0 +/-0.5
D	4.0 +/-0.3
E	300 +/- 30
F	8 X 4.4 Dia +/- 0.3
G	6.4 +/- 1.0



Frame Type (Open Flange)

	ITEM	SPECIFICATION	UNITS / NOTES
MECHANICAL	Speed	5700 +/- 10%	RPM at 12 Vdc
	Airflow	113.16	CFM in Free Air
	Static Pressure	0.79	Inch, H ₂ O
	Bearing Type	Dual Ball	N/A
	Operating Temp	(-)10 to 70	Deg C
	Storage Temp	(-) 40 to 70	Deg C
PHYSICAL	Noise Level	52.8	dBA Max at 1M
	Blade Material	UL 94V-0	N/A
	Frame Material	UL 94V-0	N/A
	Wire Size	26	AWG
	Wire Type	UL 1007	N/A
	Wire Assembly	First Slot Only	N/A
ELECTRICAL	Regulatory Approvals	UL CUL TUV	N/A
	Net Weight	TBD	Grams
	Operating Voltage	10.8 - 13.2	Vdc
	Start up Voltage	10.8	Vdc
	Rated Current	0.92 (1.05 Max)	Amp
	Input Power	11.04 (12.60 Max)	Watts
	Tach Output	NA	Pulses/Rev
	Polarity Protection	Yes	N/A
Motor Protection	Yes	Type 2	

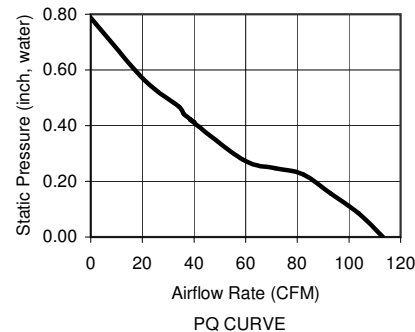

2	1	Logo Label	L09201B0003	JMC
1	1	Fan Model	9232 - 12	JMC
Item	Qty	Description	Part Number	MFG
Austin Texas, USA Dong Guan, PRC			Fan, 92x 32 mm, 12Vdc Dual Ball, Base Model	
Drawn By S. Apsangi			Size A1	Drawing Number 09201B0003
Engineer J. Elmo		Scale: None		Sheet 1 of 1

PROPRIETARY NOTE

This document is the property of JMC products and contains sensitive and confidential information. Neither this document nor any information it contains may be reproduced or distributed, without written permission by JMC products.