

WIRE DESIGNATION	
GND (-)	Black
PWR (+)	Yellow
PWM	Blue
SIGNAL (TACH)	Green

Revision History				
EC No	REV	Date	Description	Approvals
NA	X01	10/28/13	Rmvd Lw RPM Alarm Output	JE

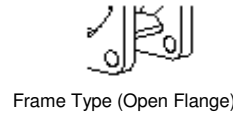

NOT RELEASED FOR PRODUCTION

NOTES

1. BASE MODEL FAN - ANY CHANGES TO SPECIFICATION REQUIRES NEW PART NUMBER.
2. THIS FAN AND ALL OF ITS COMPONENTS COMPLY WITH THE REQUIREMENTS OF RoHS DIRECTIVE 2011/65/EU
3. THIS FAN USES MICROCONTROLLER DESIGN WITH INTERNAL CLOSED LOOP SPEED CONTROL FOR RPM STABILIZATION. RPM SHALL BE WITHIN 1% OF SPECIFIED RPM VS DUTY CYCLE SPEED.

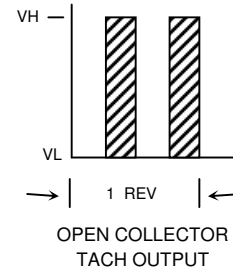
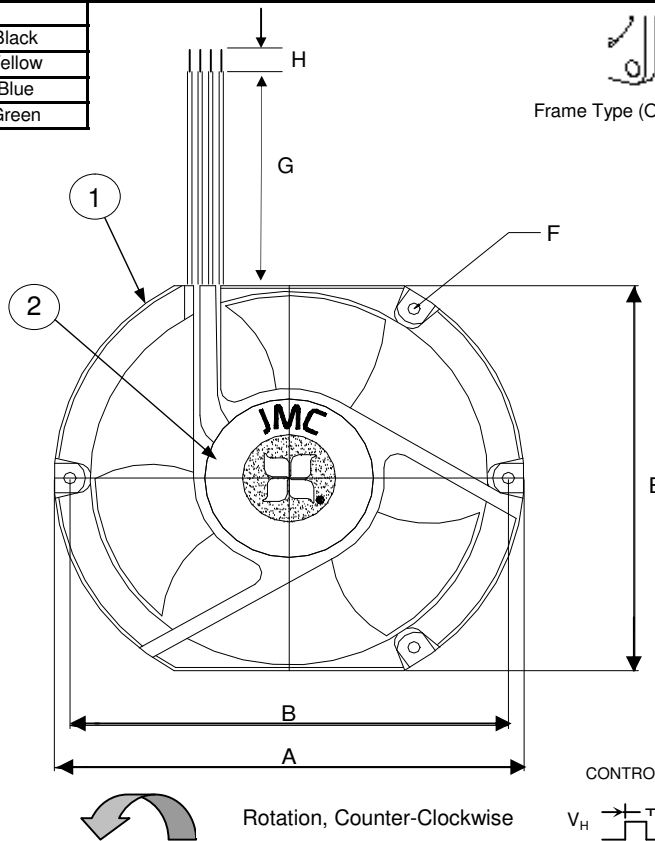
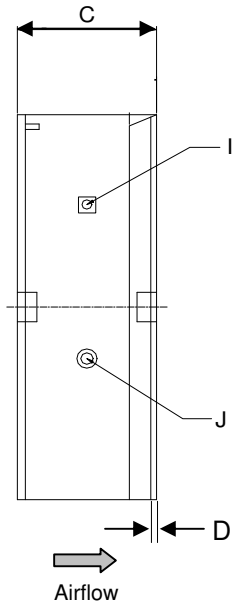

All Dimensions in mm	
A	172 +/-1.0
B	162.0 +/-0.5
C	51.5 +/-1.0
D	3.0 +/- 0.3
E	151 +/- 1.0
F	8x4.5 Dia +/- 0.3
G	300.0 +/-30
H	6.4 +/- 1.0
I	M3.5
J	M4.0

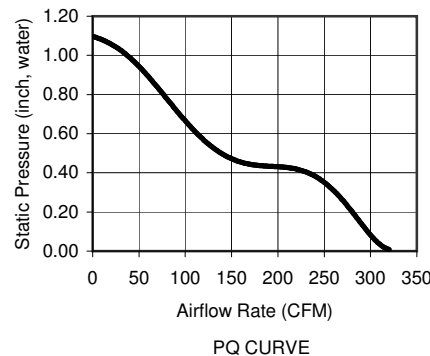
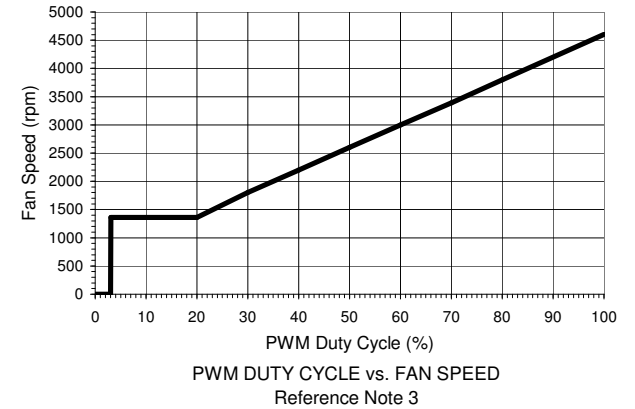
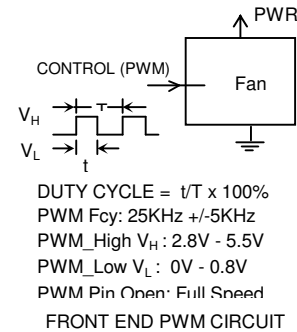

	ITEM	SPECIFICATION	UNITS / NOTES
MECHANICAL	Speed	4600	RPM at 48Vdc
	Airflow	320	CFM in Free Air
	Static Pressure	1.1	Inch, H ₂ O
	Bearing Type	Dual Ball	N/A
	Operating Temp	(-)10 to 70	Deg C
	Storage Temp	(-) 40 to 70	Deg C
	Noise Level	67.0	dBA Max at 1M
	PHYSICAL	Blade Material	Thermal Plastic
Frame Material		Aluminum Alloy	N/A
Wire Size		20	AWG
Wire Type		UL 3266	N/A
Wire Assembly		First Slot Only	N/A
ELECTRICAL	Regulatory Approvals	UL CUL TUV	N/A
	Net Weight	715.0	Grams
	Operating Voltage	38.4 - 57.6	Vdc
	Start up Duty Cycle	20	%
	Rated Current (at 48V)	0.70 (0.80 Max)	Amp
	Input Power (at 48V)	33.6 (38.4 Max)	Watts
	Tach Output	2	Pulses/Rev
	Polarity Protection	Yes	N/A
Motor Protection	Yes	Type 2	

2	1	Logo Label	L17200BU003	JMC
1	1	Fan Model	1751 - 48 366Y	JMC
Item	Qty	Description	Part Number	MFG
Austin Texas, USA		JMC The Fan Company	Fan, 172x151x51, 48 VDC, Tach, PWM, MCU, DBB, Base Model	
Dong Guan, PRC			Size	Drawing Number
Drawn By		A1	17200BU003	X01
A.Aguirre		Scale: None		
Engineer		Sheet 1 of 1		
J. Elmo				

PROPRIETARY NOTE

This document is the property of JMC products and contains sensitive and confidential information. Neither this document nor any information it contains may be reproduced or distributed, without written permission by JMC products.