

Revision History				
EC No	REV	Date	Description	Approvals
NA	X00	6/3/08	Created Drg.	SA

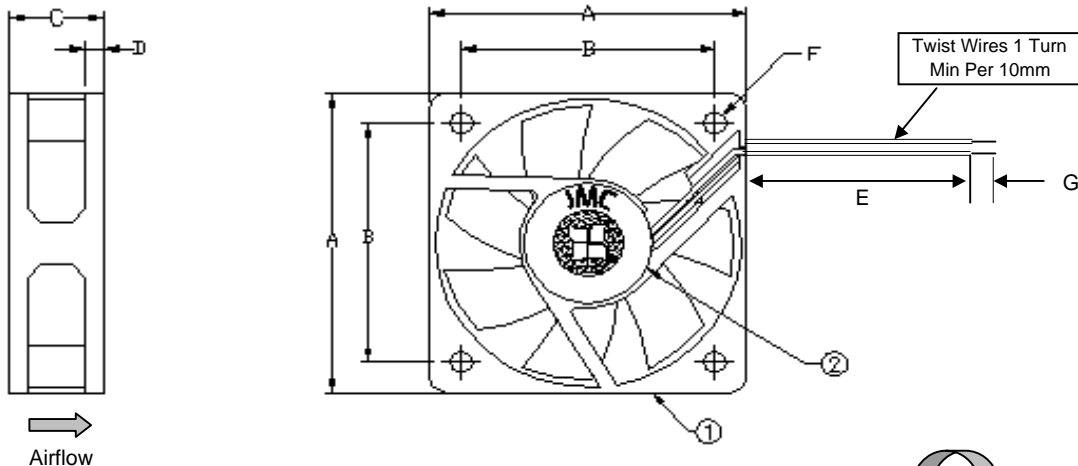

NOTES

1. THIS FAN AND ALL OF ITS COMPONENTS COMPLY WITH THE REQUIREMENTS OF RoHS DIRECTIVE 2002/95/EC
2. BASE MODEL FAN - ANY CHANGES TO SPECIFICATION REQUIRES NEW PART NUMBER.

WIRE DESIGNATION	
Wire Color	Function
Black	GND
Red	PWR, 12Vdc

All Dimensions in mm	
A	50 +/- 0.5
B	40 +/-0.3
C	15 +/-0.5
D	3.0 +/-0.3
E	300 +/- 25
F	4 X 3.7 Dia +/- 0.3
G	6.4 +/- 1.0

Rotation, Clockwise

Frame Type (Closed Barrell)

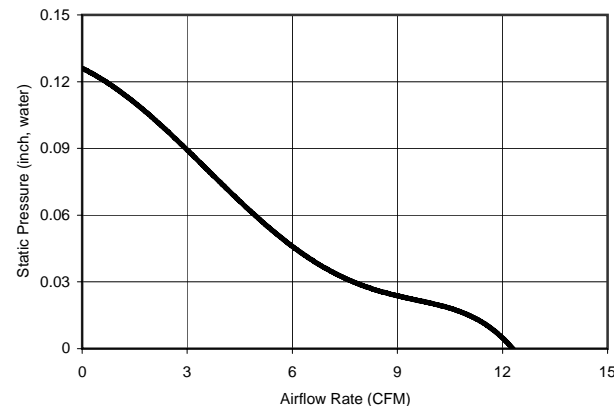

PQ CURVE

	ITEM	SPECIFICATION	UNITS / NOTES
MECHANICAL	Speed	5000 +/- 10%	RPM at 12 Vdc
	Airflow	12.3	CFM in Free Air
	Static Pressure	0.13	Inch, H ₂ O
	Bearing Type	Ball, Dual	N/A
	Operating Temp	(-)10 to 70	Deg C
	Storage Temp	(-) 40 to 70	Deg C
	Noise Level	27.5	dBA Max at 1M
PHYSICAL	Blade Material	UL 94V-0	N/A
	Frame Material	UL 94V-0	N/A
	Wire Size	26	AWG
	Wire Type	UL 1007	N/A
	Wire Assembly	First Slot Only	N/A
Regulatory Approvals	UL CUL TUV	N/A	
ELECTRICAL	Net Weight	TBD	Grams
	Operating Voltage	10.8 - 13.2	Vdc
	Start up Voltage	10.8	Vdc
	Start up PWM duty cycle	NA	%
	Rated Current	0.15	Amp
	Input Power	1.8	Watts
	Tach Output	NA	Pulses/Rev
	Polarity Protection	Yes	N/A
Motor Protection	By Impedance	N/A	

2	1	Logo Label	L05001B0002	JMC
1	1	Fan Model	5015-12	JMC
Item	Qty	Description	Part Number	MFG

Austin Texas, USA Dong Guan, PRC	 The Fan Company	FAN, 50x15 mm, 12Vdc Dual Ball, Base Model		
Drawn By S. Apsangi		Size A1	Drawing Number 05001B0002	Rev X00
Engineer J. Elmo	Scale: None		Sheet 1 of 1	

PROPRIETARY NOTE